

### Gear Operated

#### GL-10UB

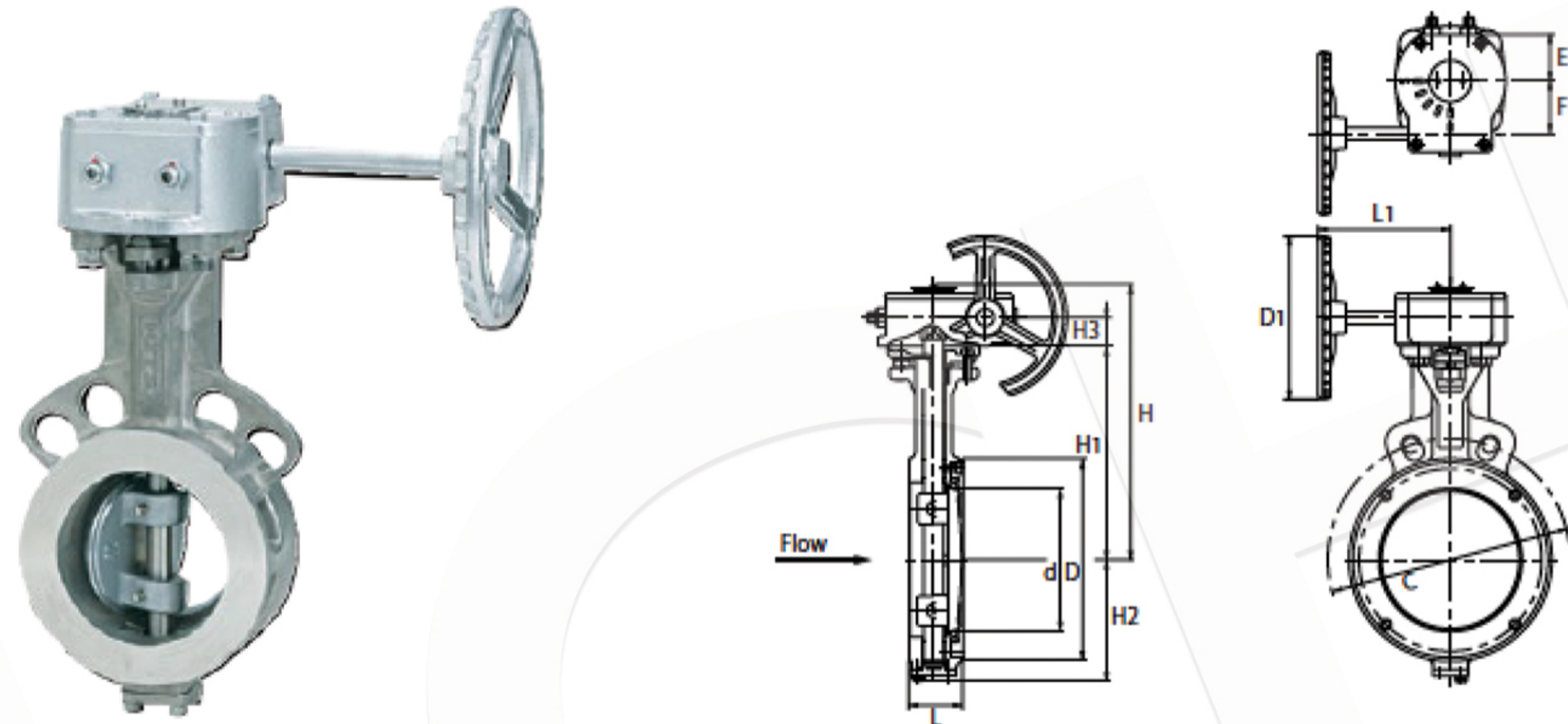

#### Dimensions

unit : mm

Size		d	H	H1	H2	H3	L	L1	D	D1	E	F	C			Gear type
mm	inch												10UB	16UB	150UB	
50	2	50	191	138	64	25	43	150	90	140	35	42	120	120	120.5	No. 1
65	2½	65	201	148	74	25	46	150	115	140	35	42	140	140	139.5	No. 1
80	3	78	225	167	82	28	46	195	126	170	42	60	150	160	152.5	No. 2
100	4	98	239	181	92	28	52	195	146	170	42	60	175	185	190.5	No. 2
125	5	123	260	202	115	28	56	204	181	200	42	60	210	225	216.5	No. 2
150	6	148	283	225	126	28	56	204	211	200	42	60	240	260	241.5	No. 2
200	8	197	350	263	164	47	71	280	257	310	54	68	290	305	298.5	No. 3
250	10	243	417	315	235	60	76	310	322	360	69	89	355	380	—	No. 4
300	12	295	444	342	258	60	83	310	367	360	69	89	400	430	—	No. 4
350	14	325	476	374	294	60	92	363	410	500	70	93.5	445	480	—	No. 5
400	16	371	572	408	315	95	102	377	470	500	90	134	510	540	—	No. 6
450	18	421	606	442	370	95	114	377	530	500	90	134	565	605	—	No. 6
500	20	470	622	458	398	95	127	377	580	500	90	134	620	660	—	No. 6
600	24	569	758	558	475	170	154	377	688	500	105	213	730	770	—	No. 7